

air prep

50 Series

High Flow FRL Series



numatics®

Table of Contents



50 Series	3-10
Features and Benefits	3
Filter	4
Regulator	5
Pilot Operated Regulator	6
Dimensions	7
Lubricator	8
Combinations-N50 Series	9
Replacement and Repair Kits	10



50 Series High Flow FRL Series

- High Flow
- High Pressure
- T Handle Adjustment Regulator
- Pilot Regulators to 2-1/2 NPT
- Rugged Design
- Metal Bowls with Sight Glass
- 1/4 to 1-1/2 NPT Size Range
- Assemblies Available



50 Series High Flow FRL Series

NUMATICS®

50 Series Filter F50B Series

- Metal bowl with sight glass standard
- Manual or automatic drain

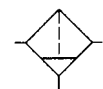

ANSI SYMBOL

Specifications

Temperature Range °F (°C)	40-150 (4.4-65)
Max. Pressure PSIG (BAR)	250 (17.2)
1/4 & 3/8 Weight, lbs. (kg.)	1.8 (.81)
1/2 Weight, lbs. (kg.)	2.8 (1.27)
3/4 & 1 Weight, lbs. (kg.)	6.3 (2.9)
1 & 1 1/2 Weight, lbs. (kg.)	7.0 (3.2)

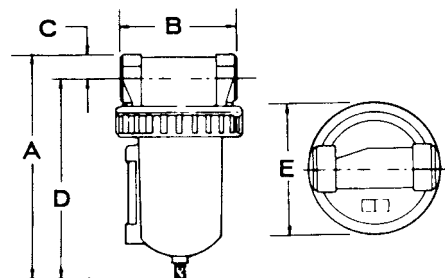

Flow Ratings

MODEL	MICRON RATING	PIPE SIZE	BOWL SIZE	SCFM
F50B-02	5	1/4	5 oz.	50
F50B-03	5	3/8	5 oz.	70
F50B-04	5	1/2	8 oz.	100
F50B-06	5	3/4	16 oz.	186
F50B-08	5	1	16 oz.	260
F50B-10	5	1 1/4	16 oz.	275
F50B-12	5	1 1/2	16 oz.	275

Dimensions

top dimensions = inches

bottom dimensions (in parenthesis) = millimeters

SIZE	A	B	C	D	E
1/4 & 3/8	5.94 (150.0)	2.50 (64.0)	0.50 (12.0)	5.50 (140.0)	2.90 (74.0)
1/2	6.43 (174.0)	3.25 (83.0)	0.60 (15.0)	6.25 (159.0)	3.8 (96.0)
3/4 & 1	8.81 (224.0)	4.56 (116.0)	1.94 (24.0)	7.88 (200.0)	4.97 (126.0)
1 1/4	9.53 (242.0)	5.19 (132.0)	1.28 (33.0)	8.25 (210.0)	4.97 (126.0)
1 1/2	9.53 (242.0)	5.19 (132.0)	1.28 (33.0)	8.25 (210.0)	4.97 (126.0)

* Flow rates based on 100 PSIG inlet and a 5 PSID.

How To Order

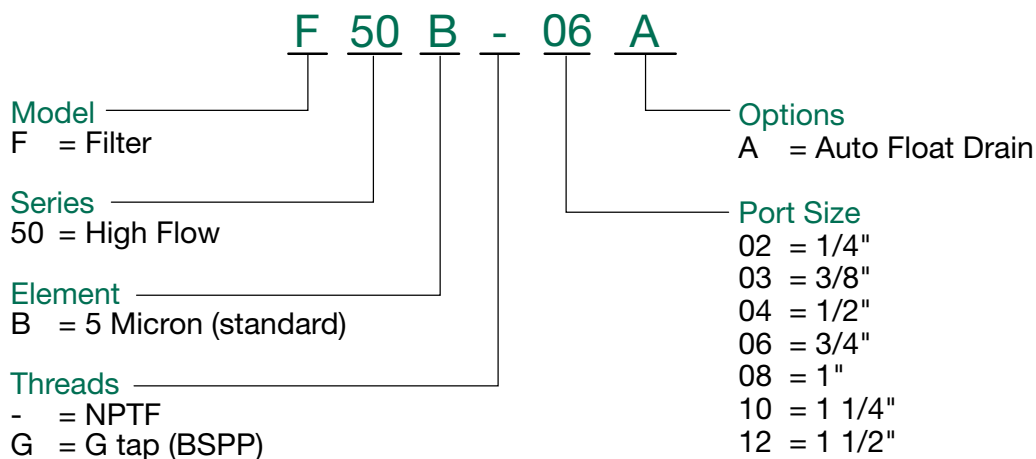

NEED MORE PARTS AND INFORMATION?

- See page 10 for information on ordering replacement parts.



50 Series Regulator R50 Series

- Diaphragm-operated regulator
- T-handle standard
- Standard output pressure 0-125 PSIG

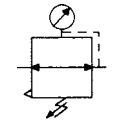

ANSI SYMBOL

Specifications

Temperature Range °F (°C)	40-120 (4.4-46.9)
Max. Pressure PSIG (BAR)	300 (20.7)
1/4 & 3/8 Weight, lbs. (kg.)	1.8 (.81)
1/2 Weight, lbs. (kg.)	2.8 (1.27)
3/4 & 1 Weight, lbs. (kg.)	6.2 (2.8)
1 & 1 1/2 Weight, lbs. (kg.)	7.2 (3.3)

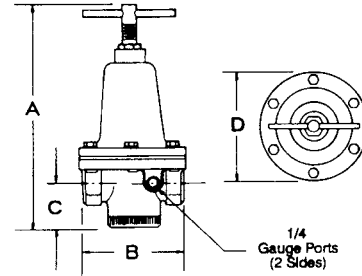

Flow Ratings

MODEL	PIPE SIZE	SCFM* @ REDUCED PRESSURE OF		
		25 PSIG	60 PSIG	80 PSIG
R50R-02	1/4	60	80	90
R50R-03	3/8	70	90	100
R50R-04	1/2	160	180	200
R50R-06	3/4	370	385	395
R50R-08	1	370	385	395
R50R-10	1 1/4	370	385	395
R50R-12	1 1/2	370	385	395

* Flow rates based on 100 PSIG inlet and 25% PSID.

Dimensions

top dimensions = inches
bottom dimensions (in parenthesis) = millimeters

SIZE	A	B	C	D
1/4 & 3/8	6.19 (157.0)	2.75 (70.0)	1.38 (35.0)	3.0 (76.0)
1/2	6.75 (171.0)	3.75 (83.0)	1.47 (37.0)	3.56 (90.0)
3/4 & 1	8.81 (224.0)	4.56 (116.0)	1.94 (49.0)	7.88 (200.0)
1 1/4	9.53 (242.0)	5.19 (132.0)	1.28 (33.0)	8.25 (210.0)
1 1/2	9.53 (242.0)	5.19 (132.0)	1.28 (33.0)	8.25 (210.0)

How To Order

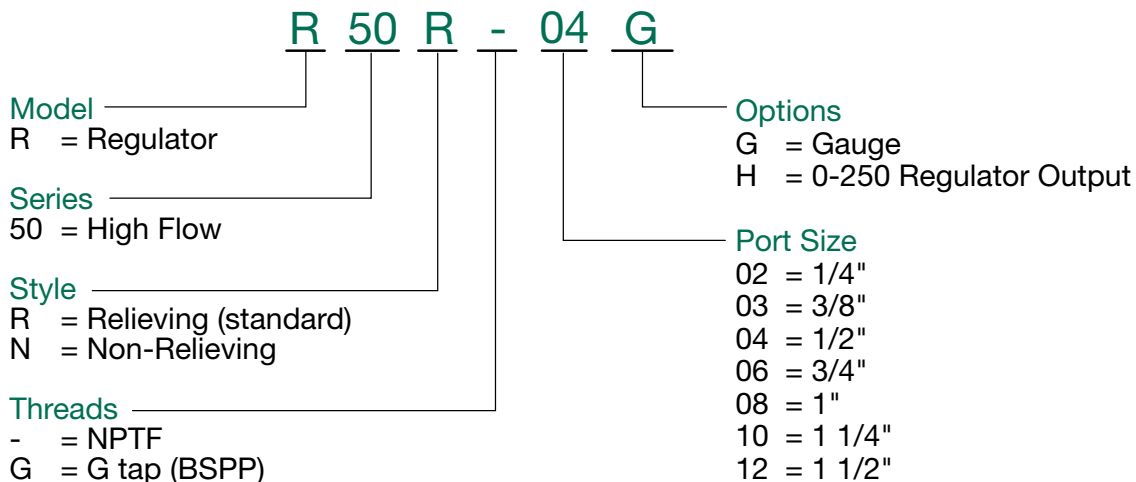

NEED MORE PARTS AND INFORMATION?

- See page 10 for information on ordering replacement parts.



50 Series High Flow FRL Series

NUMATICS®

50 Series Pilot Operated Regulator R50W Series

- High flow
- Reduced pressure within 5-7 PSIG of pilot pressure
- Relieving or non-relieving models

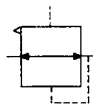

ANSI SYMBOL

Specifications

Temperature Range °F (°C)	40-120 (4.4-46.9)
Min. Pilot Pressure PSIG (BAR)	7 (.5)
Max Pilot Pressure PSIG (BAR)	300 (20)
Max. Supply pressure PSIG (BAR)	300 (20)
1/4 & 3/8 Weight, lbs. (kg.)	1.6 (.72)
1/2 Weight, lbs. (kg.)	2.6 (1.1)
3/4 & 1 Weight, lbs. (kg.)	5.2 (2.4)
1 1/4 & 1 1/2 Weight, lbs. (kg.)	5.6 (2.5)
2 & 2 1/2 Weight, lbs. (kg.)	15 (6.8)

Flow Rates (all flows based on 100 PSI inlet)

50 Series Pilot Operated Regulator (02, 03, 04)

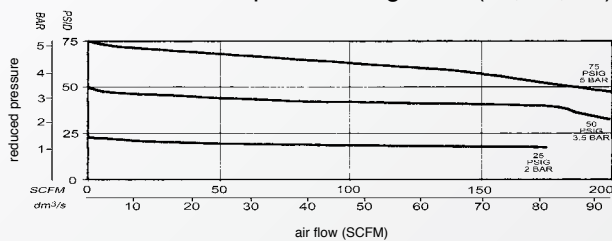

50 Series Pilot Operated Regulator (06, 08)

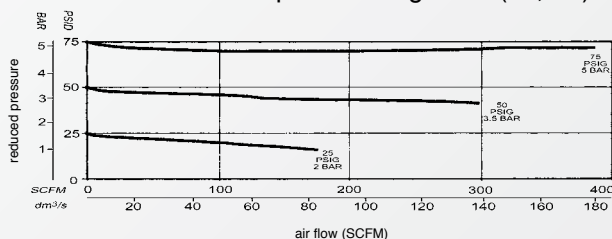

50 Series Pilot Operated Regulator (10, 12)

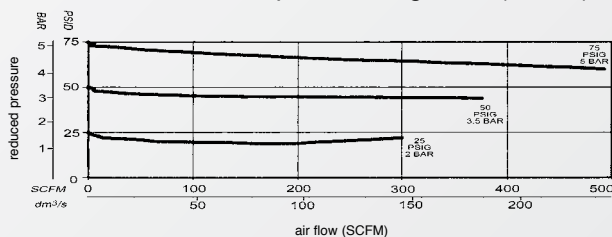

50 Series Pilot Operated Regulator (16, 20)

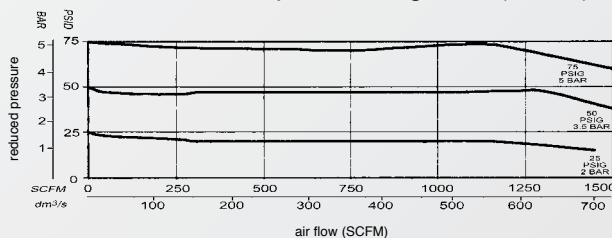

How To Order

R 50 W - 04 G -

Model	R = Regulator	Options	G = Gauge (0-160 PSIG) N = Non-Relieving (not available in 2 or 2 1/2 models)
Series	50 = High Flow	Port Size	02 = 1/4" 03 = 3/8" 04 = 1/2" 06 = 3/4" 08 = 1" 10 = 1 1/4" 12 = 1 1/2" 16 = 2" 20 = 2 1/2"
Style	W = All Pilot Operated Regulators		
Threads	- = NPTF G = G tap (BSPP)		

NEED MORE PARTS AND INFORMATION?

- See page 10 for information on ordering replacement parts.



Dimensions

top dimensions = inches
bottom dimensions (in parenthesis) = millimeters

50 Series Pilot Operated Regulator (02, 03, 04)

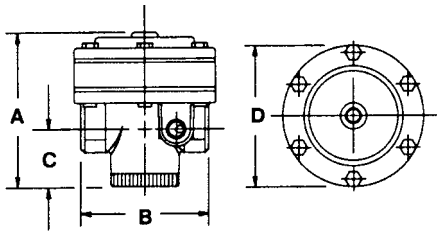

SIZE	A	B	C	D
1/4 & 3/8	3.38 (86.0)	2.75 (70.0)	1.38 (35.0)	3.0 (76.0)
1/2	3.88 (98.0)	3.25 (83.0)	1.47 (37.0)	3.56 (90.0)

50 Series Pilot Operated Regulator (06, 08)

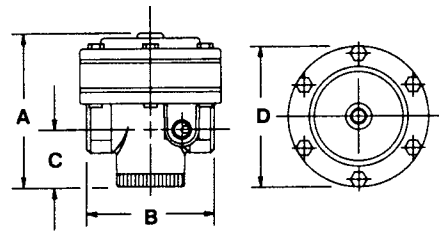

SIZE	A	B	C	D
3/4 & 1	4.84 (123.0)	4.44 (113.0)	1.93 (49.0)	4.68 (119.0)

50 Series Pilot Operated Regulator (10, 12)

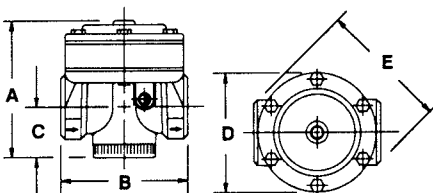

SIZE	A	B	C	D	E
1 1/4 & 1 1/2	5.20 (132.0)	4.93 (125.0)	1.88 (48.0)	4.68 (119.0)	5.55 (141.0)

50 Series Pilot Operated Regulator (16, 20)

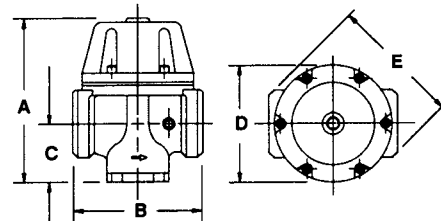

SIZE	A	B	C	D	E
2 & 2 1/2	8.88 (225.0)	7.31 (186.0)	3.09 (78.0)	6.63 (168.0)	8.0 (203.0)

*Pilot ports for all models are 1/4.



50 Series High Flow FRL Series

NUMATICS®

50 Series Lubricator

L50 Series

- High flow
- Numerical adjustment



ANSI SYMBOL

Specifications

	Std. Lub.	with "J" Option
Temperature Range °F (°C)	40-150 (4.4-65)	40-120 (4.4-49)
Max. Pressure PSIG (BAR)	250 (17.2)	150 (10.3)
1/4 & 3/8 Weight, lbs. (kg.)	2.2 (1.0)	N/A
1/2 Weight, lbs. (kg.)	3.3 (1.5)	N/A
3/4 & 1 Weight, lbs. (kg.)	4.2 (1.9)	7.2 (3.3)
1 & 1 1/2 Weight, lbs. (kg.)	7.5 (3.4)	10 (4.5)

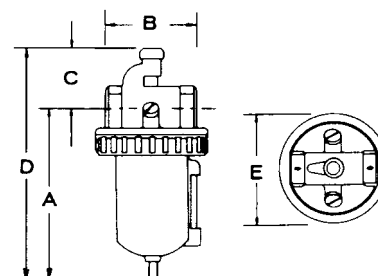

Flow Ratings

MODEL	PIPE SIZE	BOWL SIZE	SCFM*
L50L-02	1/4	5 oz.	60
L50L-03	3/8	5 oz.	90
L50L-04	1/2	8 oz.	130
L50L-06	3/4	16 oz.	300
L50L-08	1	16 oz.	325
L50L-10	1 1/4	16 oz.	500
L50L-12	1 1/2	16 oz.	570

* Flow rates based on 100 PSIG inlet and a 5 PSID.

Dimensions

top dimensions = inches

bottom dimensions (in parenthesis) = millimeters

SIZE	A	B	C	D	E
1/4 & 3/8	7.06 (179)	2.50 (64)	2.22 (56)	4.84 (123)	2.90 (74)
1/2	7.9 (201)	3.25 (83)	2.31 (59)	5.59 (142)	3.80 (97)
3/4 & 1	9.88 (251)	4.06 (103)	2.63 (67)	7.25 (184)	4.97 (126)
1 1/4	10.47 (266)	4.81 (122)	2.84 (72)	7.63 (194)	4.97 (126)
1 1/2	10.47 (266)	4.81 (122)	2.84 (72)	7.63 (194)	4.97 (126)

How To Order

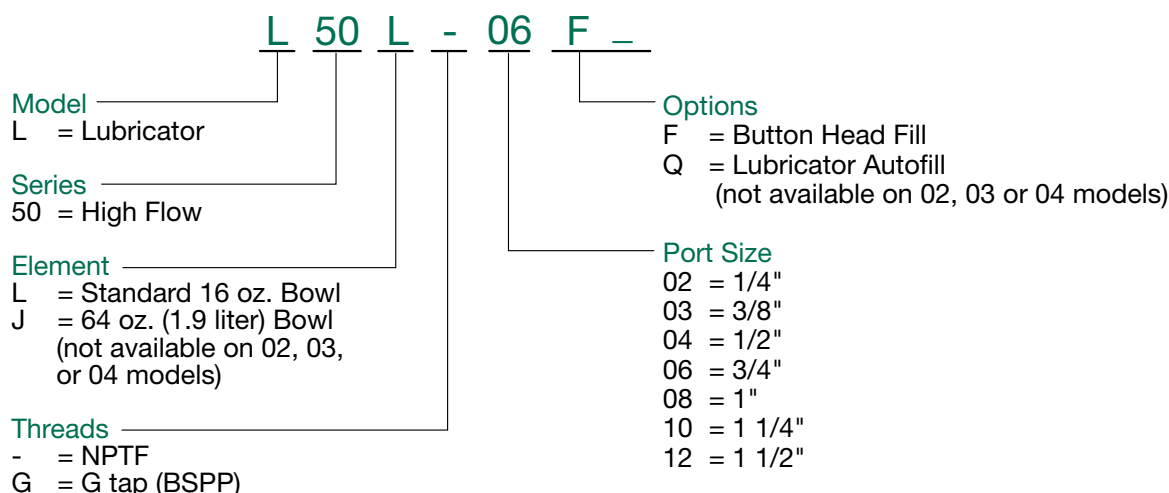

NEED MORE PARTS AND INFORMATION?

- See page 10 for information on ordering replacement parts.



50 Series Combinations – N50 Series

Filter/Regulator/Lubricator



MODEL NUMBER	PIPE SIZE NPTF	SCFM	FILTER	REGULATOR	LUBRICATOR
N50-02FRL	1/4	50	F50B-02	R50R-02	L50L-02
N50-03FRL	3/8	70	F50B-03	R50R-03	L50L-03
N50-04FRL	1/2	105	F50B-04	R50R-04	L50L-04
N50-06FRL	3/4	186	F50B-06	R50R-06	L50L-06
N50-08FRL	1	260	F50B-08	R50R-08	L50L-08
N50-10FRL	1 1/4	275	F50B-10	R50R-10	L50L-10
N50-12FRL	1 1/2	275	F50B-12	R50R-12	L50L-12

Filter/Lubricator



MODEL NUMBER	PIPE SIZE NPTF	SCFM	FILTER	LUBRICATOR
N50-02FLX	1/4	50	F50B-02	L50L-02
N50-03FLX	3/8	70	F50B-03	L50L-03
N50-04FLX	1/2	105	F50B-04	L50L-04
N50-06FLX	3/4	186	F50B-06	L50L-06
N50-08FLX	1	260	F50B-08	L50L-08
N50-10FLX	1 1/4	275	F50B-10	L50L-10
N50-12FLX	1 1/2	275	F50B-12	L50L-12

Filter/Coalescer/Regulator



MODEL NUMBER	PIPE SIZE NPTF	SCFM	FILTER	COALESCER	REGULATOR
N50-02FDR	1/4	22	F50B-02	F610D-02	R50R-02
N50-03FDR	3/8	33	F50B-03	F610D-03	R50R-03
N50-04FDR	1/2	50	F50B-04	F610D-04	R50R-04
N50-06FDR	3/4	80	F50B-06	F612D-06	R50R-06
N50-08FDR	1	100	F50B-08	F612D-08	R50R-08
N50-10FDR	1 1/4	220	F50B-10	F624D-10	R50R-10
N50-12FDR	1 1/2	250	F50B-12	F624D-12	R50R-12

How To Order

N 50 - 08 FRL A F G H

Model
Nipped Together

Series
50 = High Flow

Threads
- = NPTF
G = G tap (BSPP)

Port Size
02 = 1/4"
03 = 3/8"
04 = 1/2"
06 = 3/4"
08 = 1"
10 = 1 1/4"
12 = 1 1/2"

Options

- A = Auto Float Drain
- B = 40 Micron Filter Element
- D = Pleated Prefilter on Coalescer
- F = Lubricator Button Head Fill
- G = Regulator Gauge
- H = 0-250 PSIG Regulator Output
- J = 64 oz. Lubricator Bowl
(Not Available on 02, 03 or 04)
- N = Non-Relieving Regulator
- Q = Auto Fill Lubricator
(Not Available on 02, 03 or 04)
- R = Hex Nipple Connections
- U = Coalescer Pop-Up Indicator

Combination

- FRL = Filter/Regulator/Lubricator
- FLX = Filter/Lubricator
- FDR = Filter/Coalescer/Regulator

NEED MORE PARTS AND INFORMATION?

- See page 10 for information on ordering replacement parts.



50 Series High Flow FRL Series

NUMATICS®

Replacement Kits

50 Series High Flow Filter

> Element Replacement Kits

includes filter element only

kit #	description
EKF50A-02	50 Series, 40 micron element, 1/4"-3/8"
EKF50B-03	50 Series, 5 micron element, 1/4"-3/8"
EKF48A	50 Series, 40 micron element, 1/2"
EKF48B	50 Series, 5 micron element, 1/2"
EKF50A	50 Series, 40 micron element, 3/4"-1-1/2"
EKF50B	50 Series, 5 micron element, 3/4"-1-1/2"

> Filter Repair Kits

includes Turbo-Flo, element retainer, quiet zone baffle, deflector retainer

kit #	description
RKF50	50 Series, filter repair kit

> Bowl Replacement Kits

includes bowl, o-ring, locking ring

kit #	description
BKF50A	50 Series, 02,03,04 Series bowl
BKF50B	50 Series, 06,08,10,12 Series bowl

> Sight Glass Repair Kit

includes tube and 2 o-rings

kit #	description
SKFL50	50 Series, sight glass repair kit

50 Series High Flow Regulator

> Regulator Repair Kits

includes diaphragm and inner valve

kit #	description
RKR48RA	for R50R-02, (relieving) or for R50R-03, (relieving)
RKR48RB	for R50R-04, (relieving)
RKR50RA	for R50R-06, (relieving) or for R50R-08, (relieving)
RKR50RB	for R50R-10, (relieving) or for R50R-12, (relieving)
RKR48NA	for R50N-02, (non-relieving) or for R50N-03, (non-relieving)
RKR48NB	for R50N-04, (non-relieving)
RKR50NA	for R50N-06, (non-relieving) or for R50N-08, (non-relieving)
RKR50NB	for R50N-10, (non-relieving) or for R50N-12, (non-relieving)

50 Series High Flow Pilot Operated Regulator

> Diaphragm Repair Kits

includes upper diaphragm, lower diaphragm, inner valve

kit #	description
RKW50RA	for R50W-02, (relieving) or for R50W-03, (relieving)
RKW50RB	for R50W-04, (relieving)
RKW50RC	for R50W-06, (relieving) or for R50W-08, (relieving)
RKW50RD	for R50W-10, (relieving) or for R50W-12, (relieving)
RKW50RE	for R50W-16, (relieving) or for R50W-20, (relieving)
RKW50NA	for R50W-02N, (non-relieving) or for R50W-03N, (non-relieving)
RKW50NB	for R50W-04N, (non-relieving)
RKW50NC	for R50W-06N, (non-relieving) or for R50W-08N, (non-relieving)
RKW50ND	for R50W-10N, (non-relieving) or for R50W-12N, (non-relieving)
RKW50NE	for R50W-16N, (non-relieving) or for R50W-20N, (non-relieving)

50 Series High Flow Lubricator

> Lubricator Repair Kits

includes needle adjustment ass'y, o-ring, adjustment cap

kit #	description
RKL50	50 Series, lubricator repair kit

> Bowl Replacement Kits

includes bowl, o-ring, locking ring

kit #	description
BKL50A	50 Series, 02,03,04 Series bowl
BKL50B	50 Series, 06,08,10,12 Series bowl

> Sight Glass Repair Kit

includes tube and 2 o-rings

kit #	description
SKFL50	50 Series, sight glass repair kit

> Replacement Adjustment Knob Kits

includes adjustment knob only

kit #	description
LP50	50 Series, adjustment knob

NUMATICS

*World Class Supplier
of Pneumatic Components*

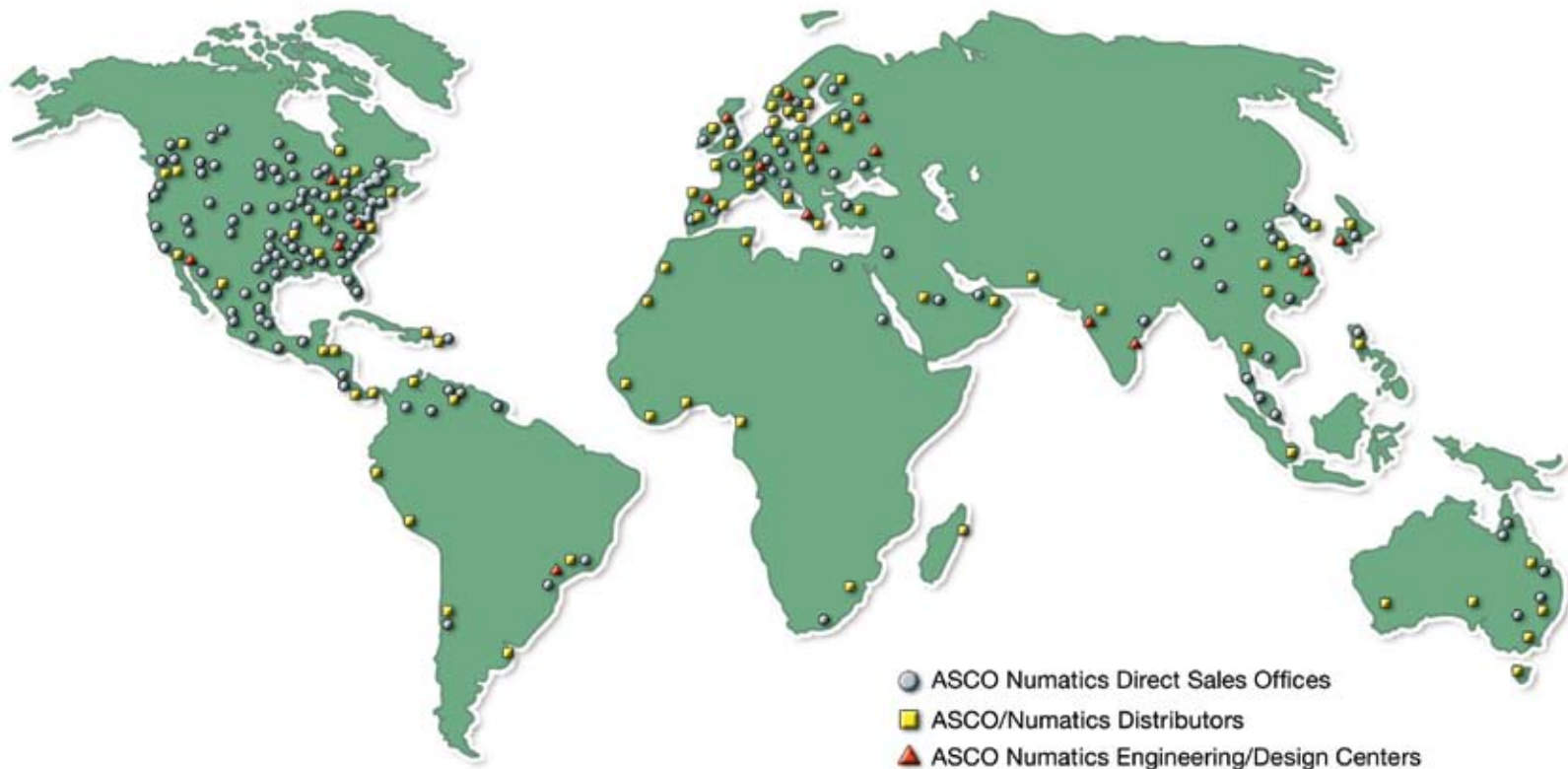

WORLD HEADQUARTERS

USA

Numatics, Incorporated

46280 Dylan Drive
Novi, Michigan 48377

P: 1-888-Numatics
1-888-686-2842

Canada

Numatics, Ltd

P: 519-452-1777

Mexico

Numatics de Mexico S.A. de C.V.

P: 52-222-284-6176

For a comprehensive listing of all Numatics production and distribution facilities worldwide, visit:

www.numatics.com